

Model 522 PS Maximus Image B

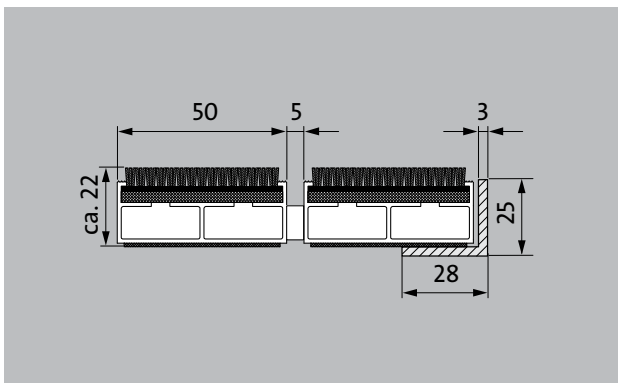
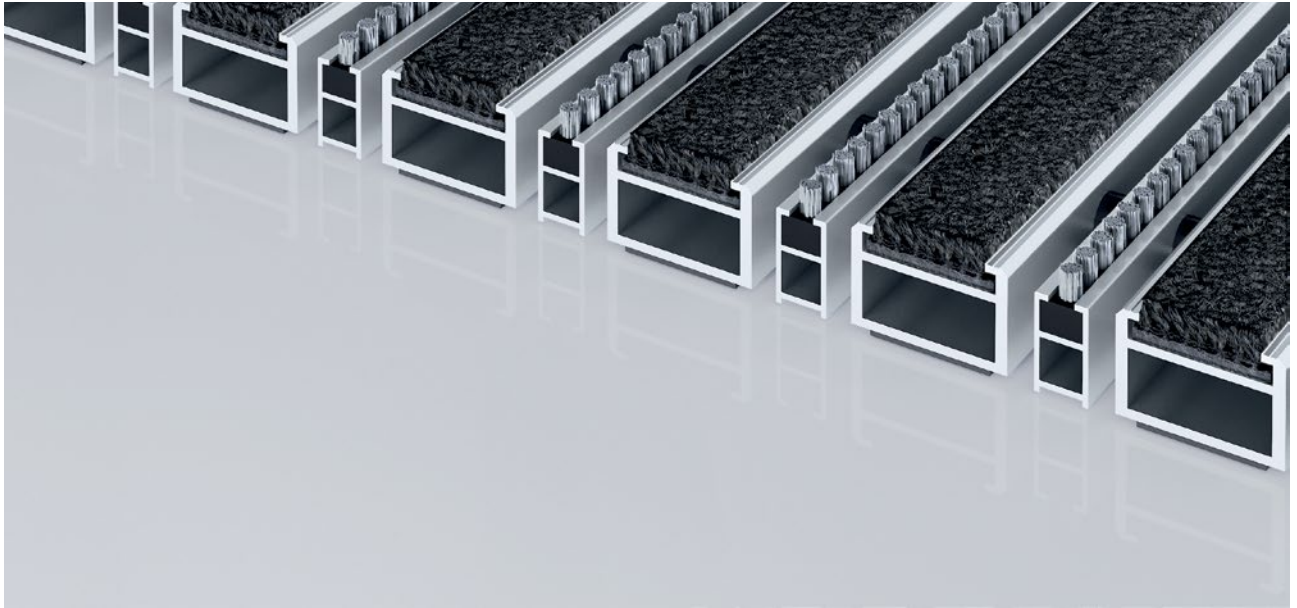

The premium entrance mat with the Maximus Image insert for single-colour printing of individual colour preferences is the number-one choice for environments that call for a unique design and exceptional reduction of fine dirt. The additional profile offers even more cleaning power. Optimally designed for buildings exposed to extreme footfall.

1 **2** **3** Indoor and outdoor (covered, Zone 1+2)

Description

Roll-up, extremely hard-wearing Premium entrance mat with Performance insert for recess installation. Suitable for single-colour printing in a personally chosen colour. Customise the width and depth without alignment profile. Available in any geometric shape.

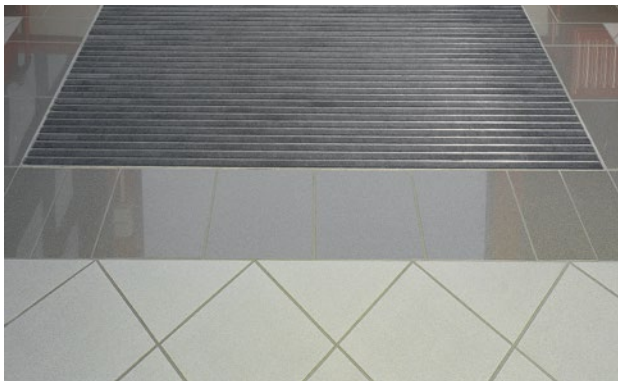

Indoor and outdoor (covered, Zone 1+2)



Street dust, hair, sand, ash, textile fibres, small leaves and twigs, etc.



Damp street dust, damp sand deposits, dust, etc.



















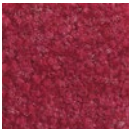







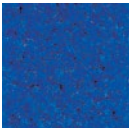

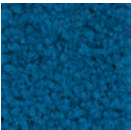

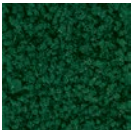
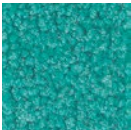
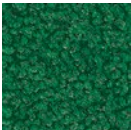
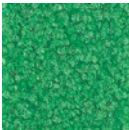
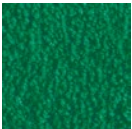

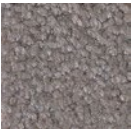

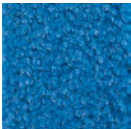



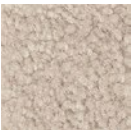

5 years guarantee

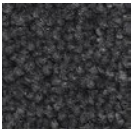

Property suitable inlay 33

Model 522 PS Maximus Image B

Colours

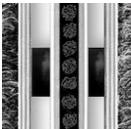
							
I10 Lemon	I20 Yellow	I30 Yellow/ orange	I40 Orange	I50 Terracotta	I60 Red	I70 Oxide red	I80 Bordeaux
							
I90 Light red	I100 Cherry	I110 Purple	I120 Lilac	I130 Grape	I140 Magenta	I150 Peach	I160 Royal blue
							
I170 Light blue	I180 Petrol blue	I190 Emerald green	I200 Marine blue	I210 Dark green	I220 Mint	I230 Leaf green	I240 Reed green
							
I250 Green	I260 Brown	I270 Graphite	I280 Steel blue	I290 Light blue	I300 Silver	I310 Fawn brown	I320 Sand
							
I330 Chestnut	I340 Grey beige	I350 Blue grey	I360 Light grey	I370 Grey	I380 Dark grey	I390 Black	I400 White*
							
I410 Steel grey	I420 Gold	I430 Salmon pink	I440 Light green	I450 Sunset	grey	Black	

Model 522 PS Maximus Image B

Approx. height (mm)	22
Roll-over and drive-over capability:	Prams Sack-/hand truck Wheelchairs
Standard profile clearance approx. (mm)	5 mm, rubber spacers
Revolving door drives	Our mats with a profile spacing of 3mm in accordance with DIN EN 16005 are available for revolving door drives.
Connection	Plastic-coated steel cable
Max. width/profile length for individual section (mm):	3000
Profile width (mm)	30
Weight (kg/m²)	15,7
Mat division as per factory standards	From a profile length of 3000 mm or a maximum mat weight of 30 kg. For profile lengths above 2300 mm, a surcharge is applicable. Mat divisions/splits possible at customer's request.
Support chassis	Reinforced support chassis made using rigid aluminium with sound absorbing insulation on the underside
Support chassis colour	Anodised colours for an additional charge: EV3 gold, C33 mid-bronze, C35 black or C31 stainless steel
Tread surface	Embedded, robust MAXIMUS inserts in Bfl-S1 quality (clean-off floor covering made from special polyamide yarn, 100%)
Flammability	Insert with fire classification Bfl-s1 according to EN 13501.
Pile material	100% PA 6.6 (polyamide)
Use classification EN1307	Property suitable inlay 33

Accessories
emco installation frame 500: 500-25 AL Aluminium
emco installation frame 500: 500-25 CN Chrome-nickel steel (V2A)
emco ramp edge: A17 Aluminium
emco T-profile: T22
emco cover strip: C22 Chrome-nickel steel (V2A)
emco INOX®: LINEO 22 Chrome-nickel steel (V2A)
emco INOX®: QUADRO 22 Chrome-nickel steel (V2A)
emco dirt collection well: 5522AL Aluminium
emco dirt collection well: 5522CN Chrome-nickel steel (V2A)
Rubber underlay 1 mm: GU 1
Rubber underlay 3 mm: GU 3
Rubber underlay 5 mm: GU 5
Mat joining brackets: MV Supplied as standard with mats in several parts

Suitable for:
Retirement homes and Care-/Nursery Homes
Arena
medical practice
Train station
DIY store
Offices and administrative buildings
Family home
Shopping centre
Retail sector
University / Higher education institution
airport
Hotel
Industry
Kindergarten/Nursery
Warehouse
Apartment building
Trade fair
School
Sports hall

Model 522 PS Maximus Image B

Service and services

Construction site advice

Dimensioning

Measured using laser measuring device on site.

Installation service

Fitting and installation service

Repairs

The product can be disposed of or recycled in an environmentally friendly way.

Warranty conditions are available at:
www.emco-bau.com/en/warranty-conditions/

Subject to technical modifications/Colours may deviate due to production processes

emco Bautechnik GmbH · Breslauer Straße 34 - 38 · D-49808 Lingen (Ems)
Germany · Phone: +49 (0) 591/9140-500 · Fax: +49 (0) 591/9140-852
Email: bau@emco.de · www.emco-bau.com

