

emco DIPLOMAT Premium z vložkom Maximus Image in strgalnim ro- bom

tip 517 P Maximus Image K

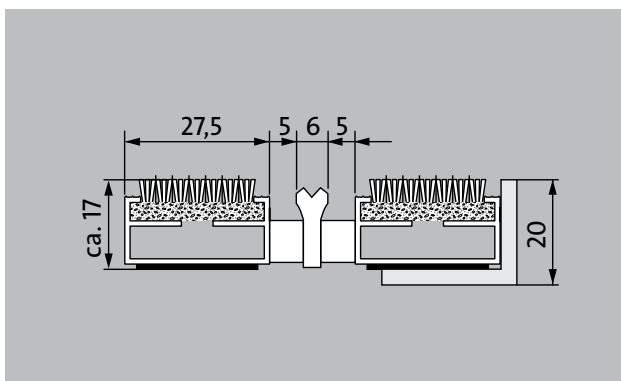
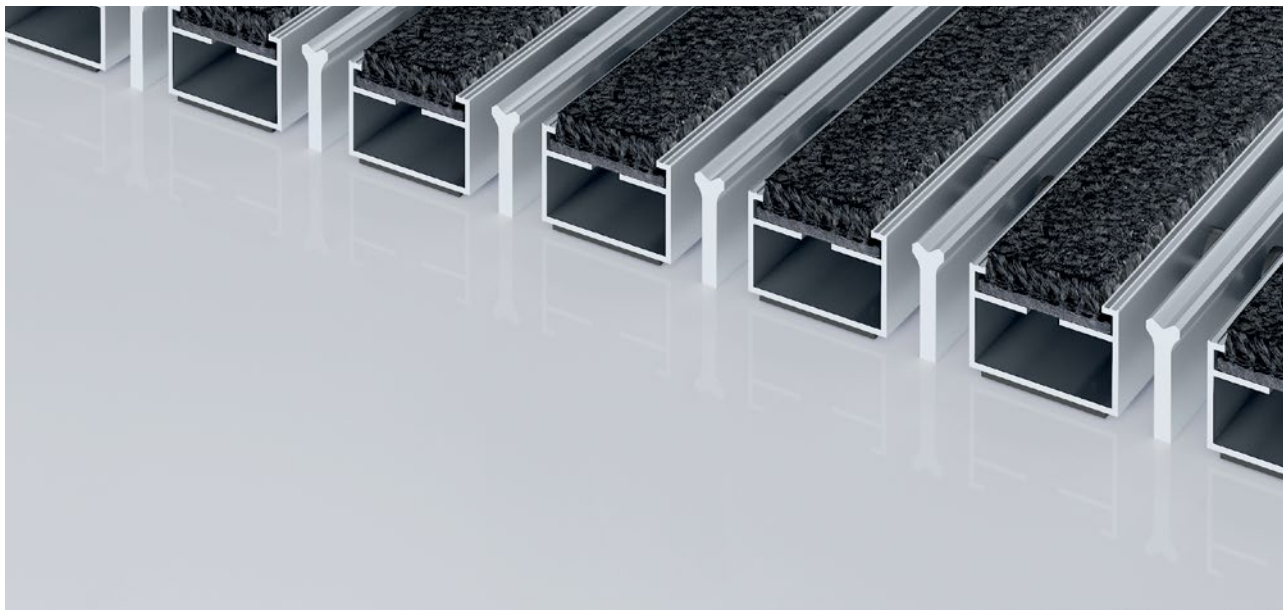

Vhodni predpražnik Premium z vložkom Maximus Image za enobarvni potisk v zeleni barvi je prva izbira, kadar gre za edinstveni dizajn in odlično zmanjšanje fine umazanije. Optimalno zasnovan za zgradbe z običajno do močno obremenitvijo.

1 **2** **3** Notranja in zunanja območja (pokrita, coni 1+2)

opis

Trpežen vhodni predpražnik Premium, ki se lahko zvije, z učinkovitim vložkom za naležno položitev. Primeren za enobarvni potisk v barvi po individualni želji. Izdelava po meri v širini in pohodni globini brez izravnalnega profila. Dobavljivo v vseh geometrijskih oblikah.



Notranja in zunanja območja (pokrita, coni 1+2)



cestni prah, lasje, pesek, pepel, tekstilna vlakna, manjši listi in vejice, itd.



moker cestni prah, peščene usedline, prah itd.



Vložek, primeren za objekt 33

emco DIPLOMAT Premium z vložkom Maximus Image in strgalnim robom

tip 517 P Maximus Image K

barve



I10 limona



I20 rumena



I30 rumenooranžna



I40 oranžna



I50 Terracotta

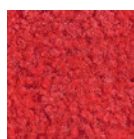

I60 rdeča

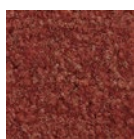

I70 Oxidnordeča

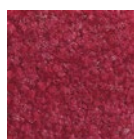

I80 Bordo



I90 svetlordeča

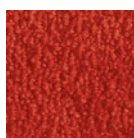

I100 češnja

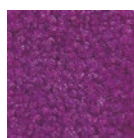

I110 vijola

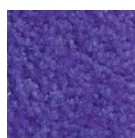

I120 Flieder



I130 Traube



I140 Magenta



I150 breskev

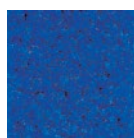

I160 kraljevsko modra

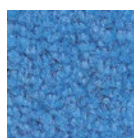

I170 svetlomodra

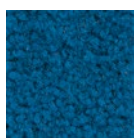

I180 Petrol

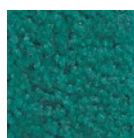

I190 Smaragdna

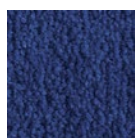

I200 Marine-modra



I210 temnozelena

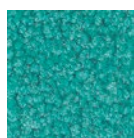

I220 Mint

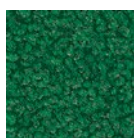

I230 listnozelena



I240 Trsnozelena

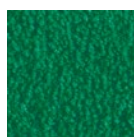

I250 zelena

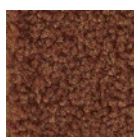

I260 rjava

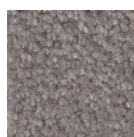

I270 grafit

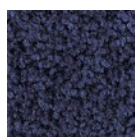

I280 jeklenomodra



I290 svetlomodra



I300 srebrna

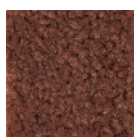

I310 srnastorjava

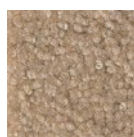

I320 peščena

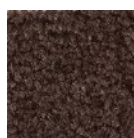

I330 kostanjeva

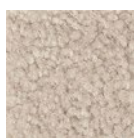

I340 sivobež

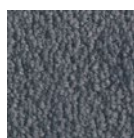

I350 modrosiva

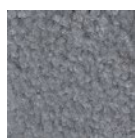

I360 svetlosiva

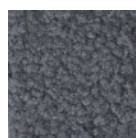

I370 siva

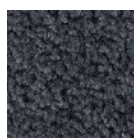

I380 temnosiva



I390 črna

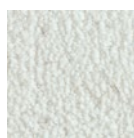

I400 bela*

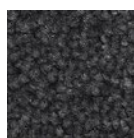

I410 jeklenosiva

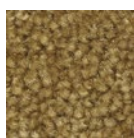

I420 zlata



I430 losos

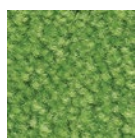

I440 svetlozelena



I450 Sunset

emco DIPLOMAT Premium z vložkom Maximus Image in strgalnim robom

tip 517 P Maximus Image K

| | |
|--|--|
| ca. Višina (mm) | 17 |
| povožnost | otroški voziček Voziček za vreče invalidski voziček |
| standarden razmik med profili ca. (mm) | 5, distančniki iz gume |
| Vrtljiva vrata | Za vrtljiva vrata so na voljo naši predpražniki s 3-mm razmikom med prečkami v skladu s standardom DIN EN 16005. |
| povezava | s plastiko ovito jekleno vrstico |
| širina profila (mm) | 27,5 |
| teža (kg/m²) | 10,3 |
| Razdelitev predpražnika po tovarniških standardih | od dolžine profila 3.000 mm ali maksimalne mase predpražnika 30 kg naprej. Dolžine profilov od 2.300 mm naprej za doplačilo. Razdelitev predpražnika je na voljo na željo stranke. |
| nosilni profil | iz aluminija z izolacijo proti pohodnemu zvoku na spodnji strani |
| Barva profila podpore | Ob doplačilu barve eloksiranja: EV3 zlata, C33 srednje bronasto eloksirano, C35 črna barva ali C31 nerjavno jeklo |
| nastopna ploskev | Vložek Maximus-Image je primeren za enobarvni potisk v barvi po individualni želji. Dodatni profil poveča učinek čiščenja. |
| gorljivost | Obnašanje vložka pri požaru v skladu z evropskim standardom EN 13501 v Bfl-s1. |
| Material z rebrasto zgornjo površino | 100 % PA 6.6 (poliamid) |
| Razred obremenitve | Vložek, primeren za objekt 33 |

oprema

emco vgradni okvir 500: 500-20 AL aluminij

emco vgradni okvir 500: 500-20 CN inox (V2A)

emco naležni profil: A17 aluminij

emco T-Profil: T17

emco pokrovna šina: C17 inox (V2A)

emco INOX®: LINEO 17 inox (V2A)

emco INOX®: QUADRO 17 inox (V2A)

emco zbiralna posoda za umazanijo: 5517AL aluminij

emco zbiralna posoda za umazanijo: 5517CN inox (V2A)

Gumijasta podloga 1 mm: GU1

Garancijski pogoji so na voljo na spletni povezavi:
www.emco-bau.com/sl/garancijski-pogoji-vhodnih-predpraznikov-emco/

Gumijasta podloga 3 mm: GU3

Pridržujemo si pravico do tehničnih sprememb / zaradi proizvodnega procesa lahko pride do barvnih odstopanj

Gumijasta podloga 5 mm: GU5

emco, proizvajalec inht. Proizvajalca: emco, DE-49808 Hiltropredpraznikih
Tel: +49 (0) 591/9140-500 Fax: +49 (0) 591/9140-852

e-naslov: bau@emco.de · www.emco-bau.com

Primerno za:

Dom upokojencev in negovalni dom

Zdravniška ordinacija

pisarniški in upravni prostori

Enodružinska hiša

Trgovina na drobno

Hotel

Vrtec

Večdružinska hiša

Šola

Športna dvorana

Vložek je certificiran v skladu s postopkom TÜV PROFICERT - product Interior (Standard)

Francoška uredba VOC (Uredba o hlapnih organskih snoveh)

LEED v4 (izven Severne Amerike)

Eksemplarična stopnja BREEM

Belgijska uredba VOC (Uredba o hlapnih organskih snoveh)

AgBB (Odbor za zdravstveno vrednotenje gradbenih proizvodov)

MVV TB Priloga 8, 9 / Splošni pogoji

servis in usluge.

svetovanje za gradbišča

izmera

izmera z laserkim aparatom na licu mesta

polagalski servis

polagalski in vpasovalni servis

popravila

Izdelek se lahko odstrani primerno okolju ali reciklira.

